

Standard Rectifier Module

$$V_{RRM} = 2 \times 1400 \text{ V}$$

$$I_{FAV} = 120 \text{ A}$$

$$V_F = 1.13 \text{ V}$$

Phase leg

Part number

MDD95-14N1B

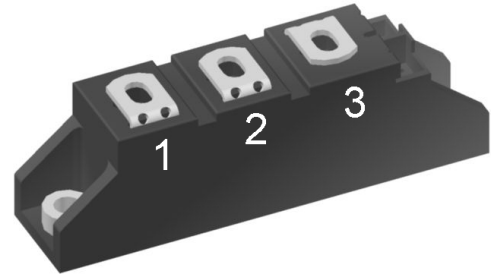

Backside: isolated

 E72873

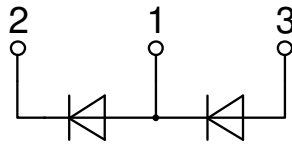

Features / Advantages:

- Package with DCB ceramic
- Improved temperature and power cycling
- Planar passivated chips
- Very low forward voltage drop
- Very low leakage current

Applications:

- Diode for main rectification
- For single and three phase bridge configurations
- Supplies for DC power equipment
- Input rectifiers for PWM inverter
- Battery DC power supplies
- Field supply for DC motors

Package: TO-240AA

- Isolation Voltage: 3600 V~
- Industry standard outline
- RoHS compliant
- Height: 30 mm
- Base plate: DCB ceramic
- Reduced weight
- Advanced power cycling

Terms Conditions of usage:

The data contained in this product data sheet is exclusively intended for technically trained staff. The user will have to evaluate the suitability of the product for the intended application and the completeness of the product data with respect to his application. The specifications of our components may not be considered as an assurance of component characteristics. The information in the valid application- and assembly notes must be considered. Should you require product information in excess of the data given in this product data sheet or which concerns the specific application of your product, please contact your local sales office.

Due to technical requirements our product may contain dangerous substances. For information on the types in question please contact your local sales office.

Should you intend to use the product in aviation, in health or life endangering or life support applications, please notify. For any such application we urgently recommend

- to perform joint risk and quality assessments;

- the conclusion of quality agreements;

- to establish joint measures of an ongoing product survey, and that we may make delivery dependent on the realization of any such measures.

Rectifier				Ratings			
Symbol	Definition	Conditions	min.	typ.	max.	Unit	
V_{RSM}	max. non-repetitive reverse blocking voltage	$T_{VJ} = 25^{\circ}C$			1500	V	
V_{RRM}	max. repetitive reverse blocking voltage	$T_{VJ} = 25^{\circ}C$			1400	V	
I_R	reverse current	$V_R = 1400 V$	$T_{VJ} = 25^{\circ}C$		200	μA	
		$V_R = 1400 V$	$T_{VJ} = 150^{\circ}C$		15	mA	
V_F	forward voltage drop	$I_F = 150 A$	$T_{VJ} = 25^{\circ}C$		1.20	V	
		$I_F = 300 A$			1.43	V	
		$I_F = 150 A$	$T_{VJ} = 125^{\circ}C$		1.13	V	
		$I_F = 300 A$			1.46	V	
I_{FAV}	average forward current	$T_C = 100^{\circ}C$	$T_{VJ} = 150^{\circ}C$		120	A	
$I_{F(RMS)}$	RMS forward current	180° sine			180	A	
V_{FO}	threshold voltage	} for power loss calculation only	$T_{VJ} = 150^{\circ}C$		0.75	V	
r_F	slope resistance				1.95	m Ω	
R_{thJC}	thermal resistance junction to case				0.26	K/W	
R_{thCH}	thermal resistance case to heatsink			0.20		K/W	
P_{tot}	total power dissipation		$T_C = 25^{\circ}C$		481	W	
I_{FSM}	max. forward surge current	$t = 10 ms; (50 Hz), sine$	$T_{VJ} = 45^{\circ}C$		2.80	kA	
		$t = 8,3 ms; (60 Hz), sine$	$V_R = 0 V$		3.03	kA	
		$t = 10 ms; (50 Hz), sine$	$T_{VJ} = 150^{\circ}C$		2.38	kA	
		$t = 8,3 ms; (60 Hz), sine$	$V_R = 0 V$		2.57	kA	
I^2t	value for fusing	$t = 10 ms; (50 Hz), sine$	$T_{VJ} = 45^{\circ}C$		39.2	kA ² s	
		$t = 8,3 ms; (60 Hz), sine$	$V_R = 0 V$		38.1	kA ² s	
		$t = 10 ms; (50 Hz), sine$	$T_{VJ} = 150^{\circ}C$		28.3	kA ² s	
		$t = 8,3 ms; (60 Hz), sine$	$V_R = 0 V$		27.5	kA ² s	
C_J	junction capacitance	$V_R = 400 V; f = 1 MHz$	$T_{VJ} = 25^{\circ}C$		116	pF	

Package TO-240AA				Ratings		
Symbol	Definition	Conditions	min.	typ.	max.	Unit
I_{RMS}	RMS current	per terminal			200	A
T_{VJ}	virtual junction temperature		-40		150	°C
T_{op}	operation temperature		-40		125	°C
T_{stg}	storage temperature		-40		125	°C
Weight					76	g
M_D	mounting torque		2.5		4	Nm
M_T	terminal torque		2.5		4	Nm
$d_{Spp/App}$	creepage distance on surface striking distance through air	terminal to terminal	13.0	9.7		mm
$d_{Spb/Apb}$		terminal to backside	16.0	16.0		mm
V_{ISOL}	isolation voltage	t = 1 second			3600	V
		t = 1 minute	50/60 Hz, RMS; $I_{ISOL} \leq 1$ mA		3000	V

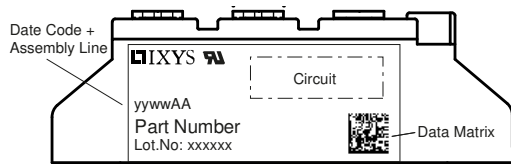

Ordering	Ordering Number	Marking on Product	Delivery Mode	Quantity	Code No.
Standard	MDD95-14N1B	MDD95-14N1B	Box	36	453153

Similar Part	Package	Voltage class
MDD95-08N1B	TO-240AA	800
MDD95-12N1B	TO-240AA	1200
MDD95-16N1B	TO-240AA	1600
MDD95-18N1B	TO-240AA	1800

Equivalent Circuits for Simulation

* on die level

$T_{VJ} = 150$ °C

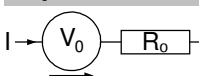

Rectifier

$V_{0\ max}$	threshold voltage	0.75	V
$R_{0\ max}$	slope resistance *	0.76	mΩ

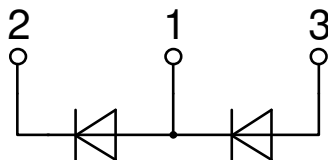
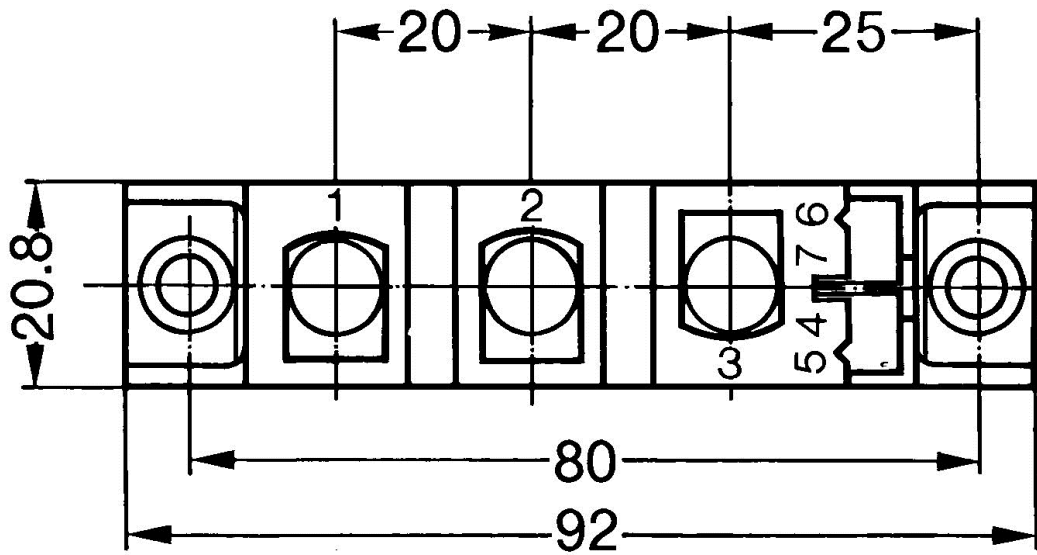
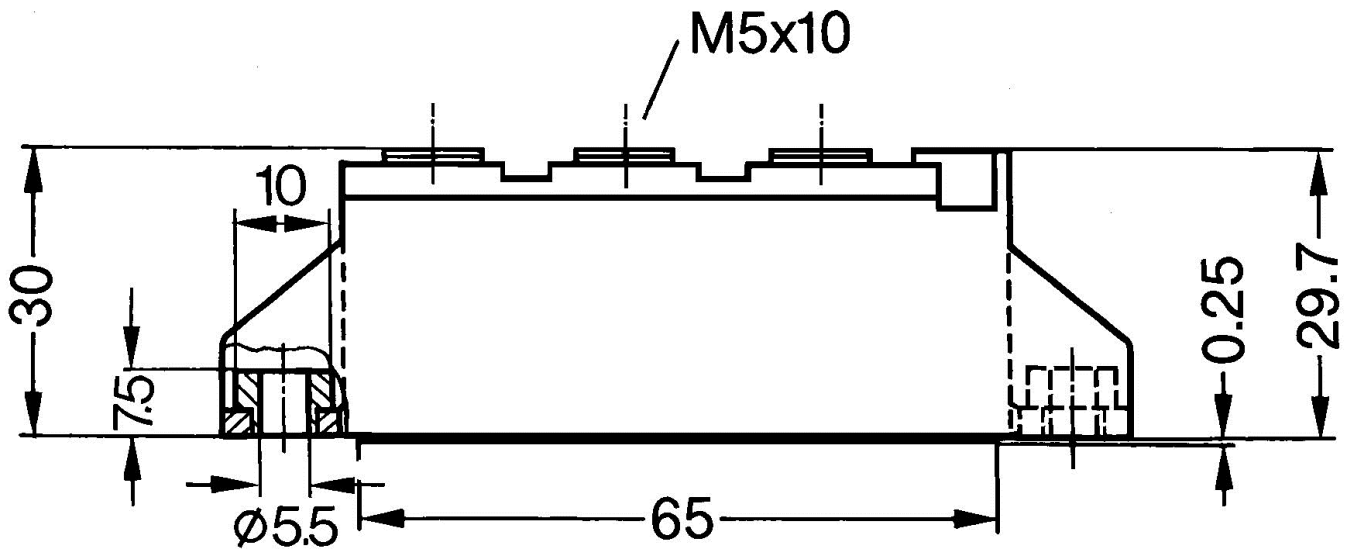

Rectifier

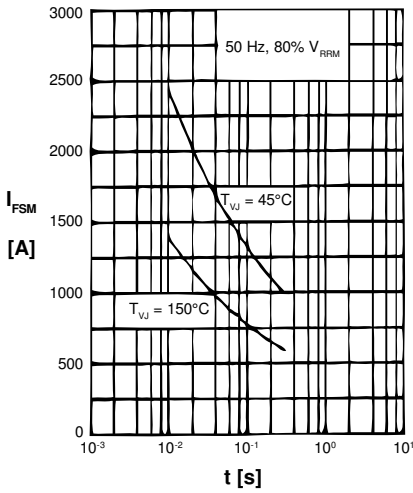

Fig. 1 Surge overload current
 I_{TSM} , I_{FSM} : Crest value, t : duration

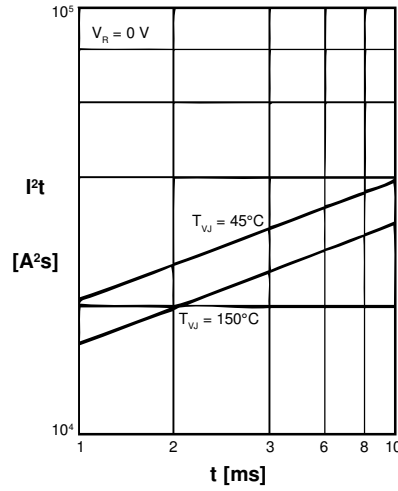

Fig. 2 I^2t versus time (1-10 ms)

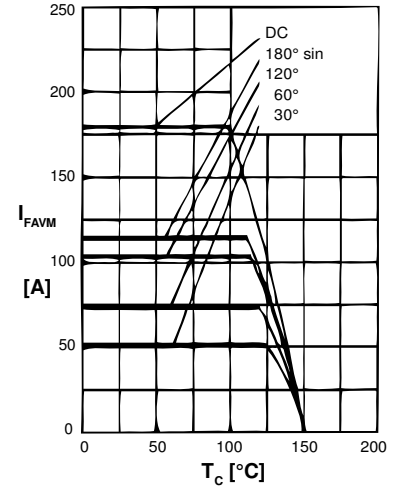

Fig. 3 Maximum forward current at case temperature

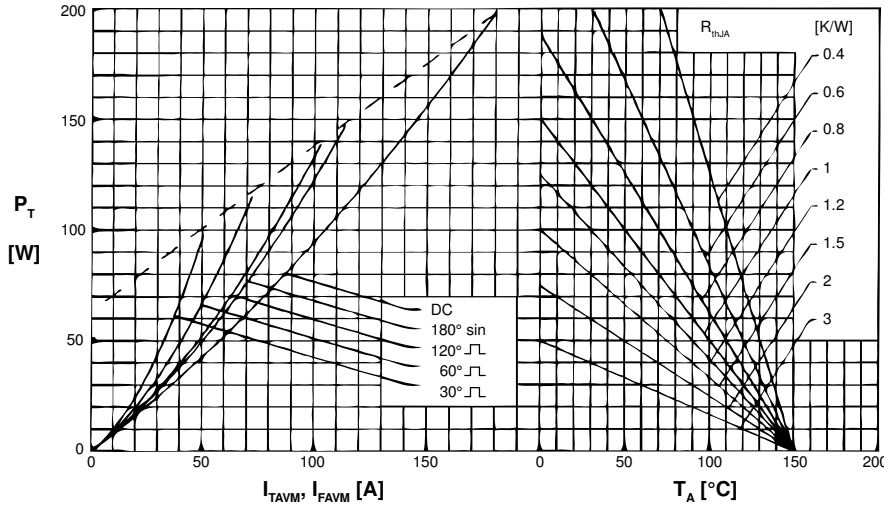

Fig. 4 Power dissipation vs. onstate current and ambient temperature (per diode)

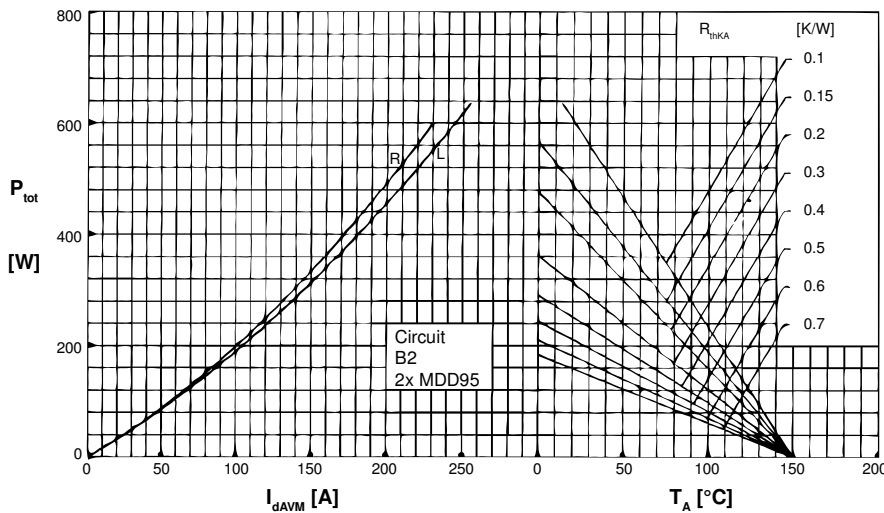

Fig. 6 Single phase rectifier bridge: Power dissipation versus direct output current and ambient temperature; R = resistive load, L = inductive load

Rectifier

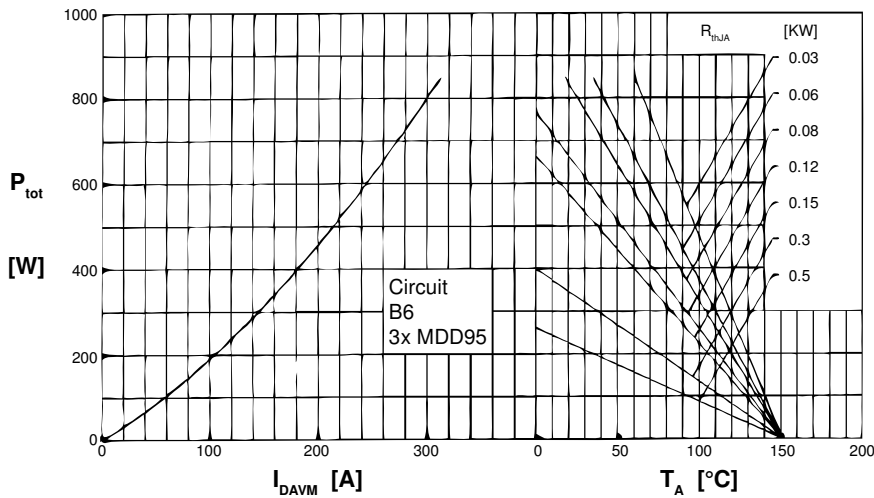

Fig. 6 Three phase rectifier bridge: Power dissipation versus direct output current and ambient temperature

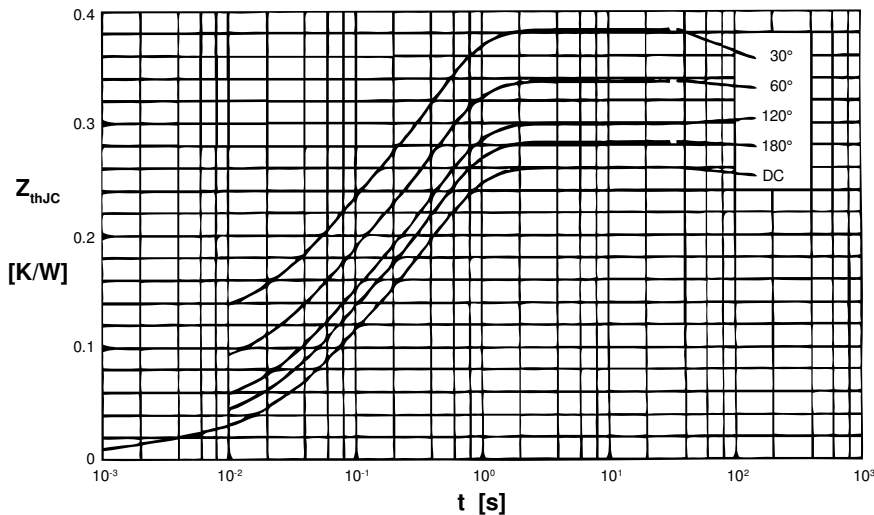

Fig. 7 Transient thermal impedance junction to case (per diode)

R_{thJC} for various conduction angles d:

d	R_{thJC} [K/W]
DC	0.26
180°	0.28
120°	0.30
60°	0.34
30°	0.38

Constants for Z_{thJC} calculation:

i	R_{thi} [K/W]	t_i [s]
1	0.013	0.0012
2	0.072	0.0470
3	0.175	0.3940

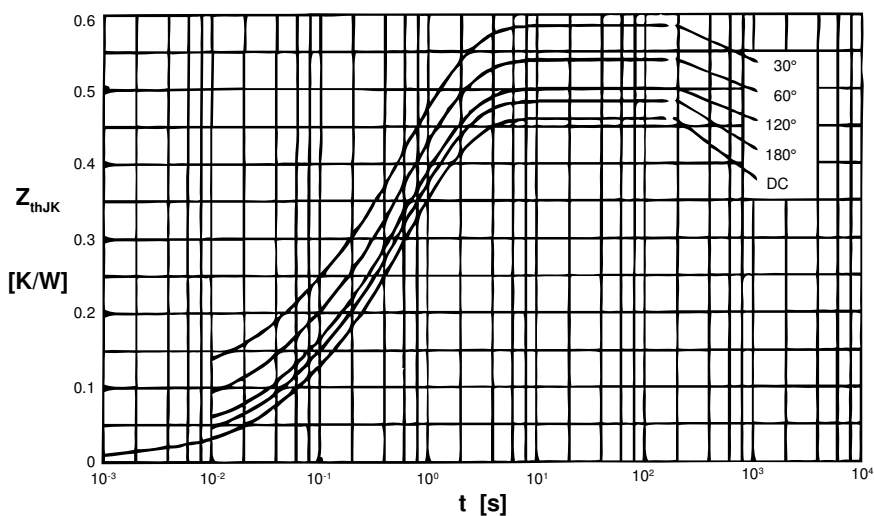

Fig. 8 Transient thermal impedance junction to heatsink (per thyristor)

R_{thJK} for various conduction angles d:

d	R_{thJK} [K/W]
DC	0.46
180°	0.48
120°	0.50
60°	0.54
30°	0.58

Constants for Z_{thJK} calculation:

i	R_{thi} [K/W]	t_i [s]
1	0.013	0.0012
2	0.072	0.0470
3	0.175	0.3940
4	0.200	1.3200