



LIGHTING FOREVER

Technical Data Sheet

High Power Infrared LED

HIR-C06/L298-P01/TR

Features

- Small package with high efficiency
- Peak wavelength $\lambda_p=850\text{nm}$
- Soldering methods:SMT
- Thermal resistance (junction to lead): 40 $^{\circ}\text{C}/\text{W}$.
- Moisture Sensitivity Level: 1
- Pb free
- The product itself will remain within RoHS compliant version.

Descriptions

- HIR-C06/L298-P01/TR series is an infrared emitting diode in miniature SMD package which is molded in a water clear silicone with spherical top view lens.
- The device is spectrally matched with silicon photodiode, Phototransistor.

Applications

- CCD Camera
- Night Vision
- Infrared applied system

HIR-C06/L298-P01/TR

Package Dimensions

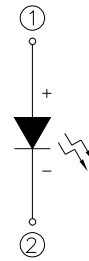
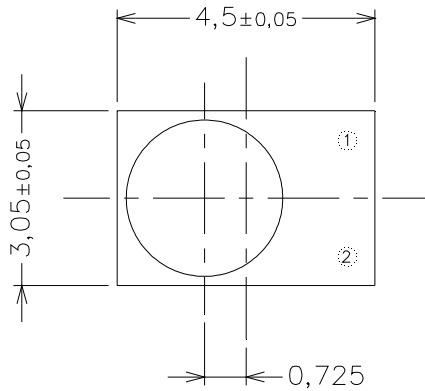

Polarity

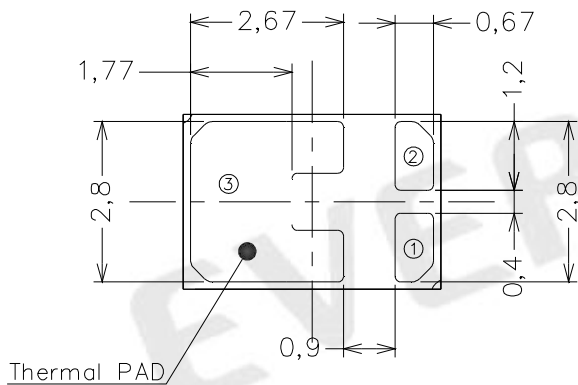
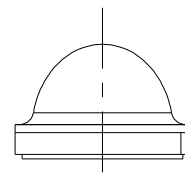
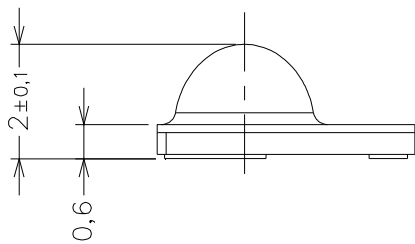

Bot. view

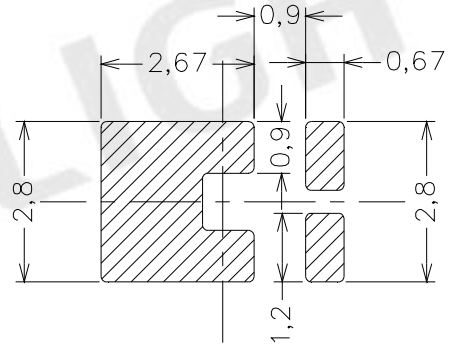

Soldering patterns

1. Dimensions are in millimeters.
2. Tolerances unless mentioned are ± 0.1 mm.
3. Do not handle the device by the lens. Incorrect force applied to the lens may lead to the failure of devices.

Pad Configuration

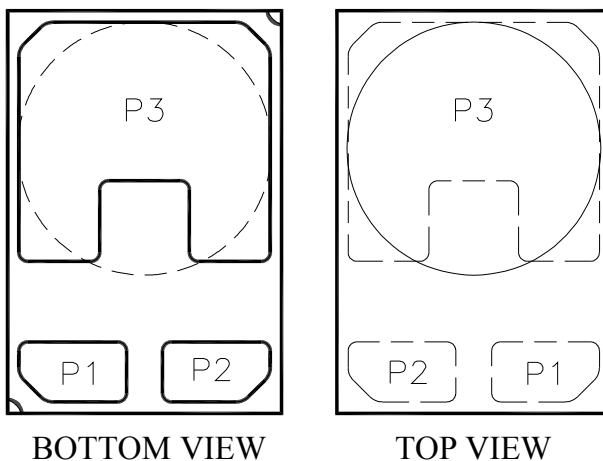

PAD	FUNCTION
P1	ANODE
P2	CATHODE
P3	THERMAL PAD

HIR-C06/L298-P01/TR

Absolute Maximum Ratings (Ta=25)

Parameter	Symbol	Rating	Unit
Forward Current	I_F	700	mA
Reverse Voltage	V_R	5	V
Operating Temperature	T_{opr}	-40 ~ +85	
Storage Temperature	T_{stg}	-40 ~ +100	
Junction temperature	T_j	115	°C
Thermal resistance (junction to leadframe)	$R_{th(j-L)}$	40	/W
Power Dissipation @ $I_F=700mA$	P_d	1	W

Note: We suggest that customer should add the heat sink with HIR-C06/L298-P01/TR to exclude the heat.

Electro-Optical Characteristics (Ta=25)

Parameter	Symbol	Condition	Min.	Typ.	Max.	Unit
Total Radiated Power	P_o	$I_F=350mA$	120	180	--	mW
		$I_F=700mA$	250	350	--	
		$I_F=1A$, Pulse Width 100 μs ,Duty 1%	--	480	--	
Radiant Intensity	I_E	$I_F=350mA$	40	70	--	mW/sr
		$I_F=700mA$	80	140	--	
		$I_F=1A$, Pulse Width 100 μs ,Duty 1%	--	180	--	
Peak Wavelength	ρ	$I_F=350mA$	--	855	--	nm
Spectral Bandwidth		$I_F=350mA$	--	25	--	nm
Forward Voltage	V_F	$I_F=350mA$	1.4	1.7	2.2	V
		$I_F=700mA$	1.5	1.9	2.5	
Reverse Current	I_R	$V_R=5V$	--	--	10	μA
View Angle	2 1/2	$I_F=20mA$	--	120	--	deg

HIR-C06/L298-P01/TR

Typical Electro-Optical Characteristics Curves

Fig.1 Forward Current vs. Ambient Temperature

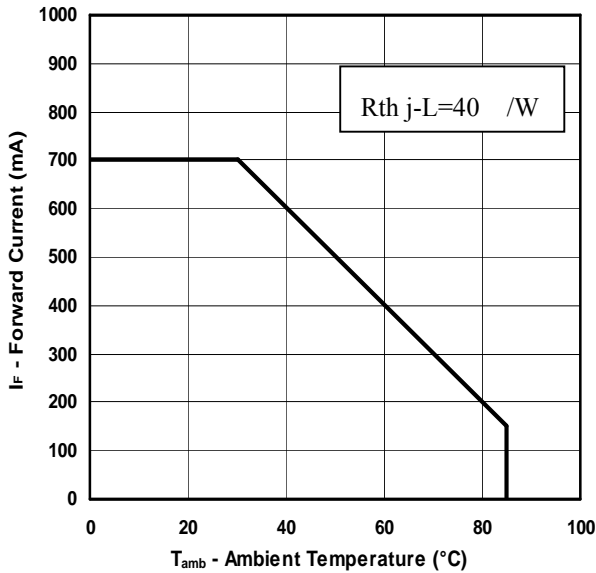

Fig.2 Spectral Distribution

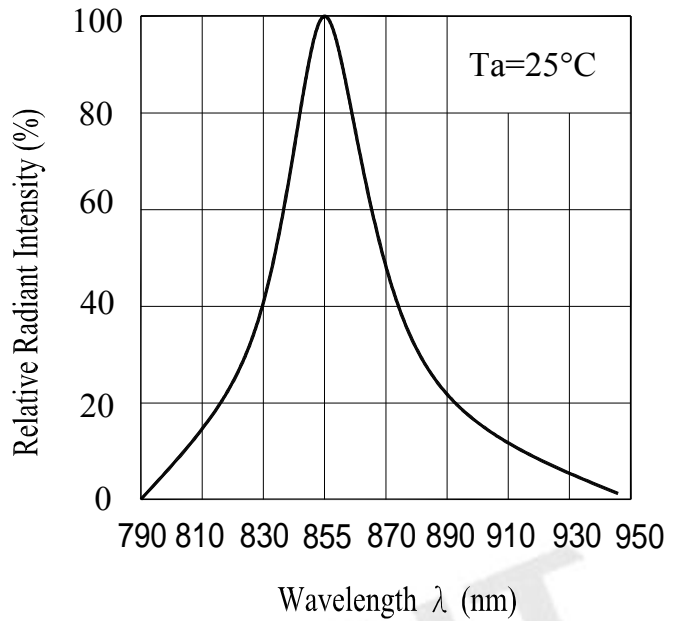

Fig.3 Radiant Intensity vs. Forward Current

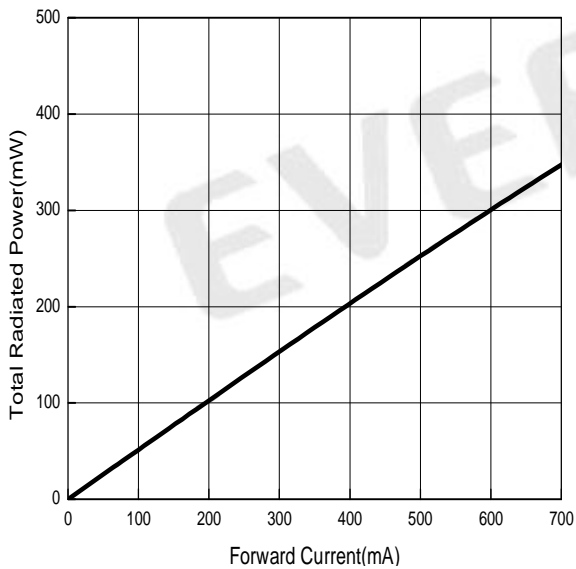
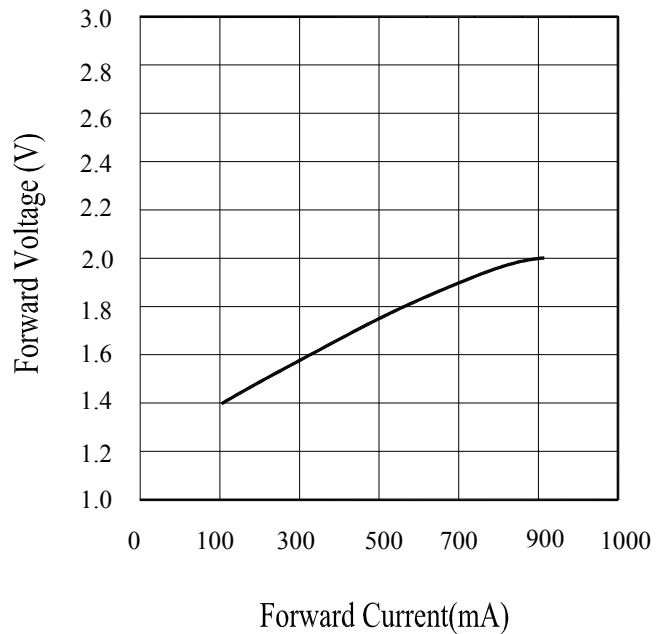
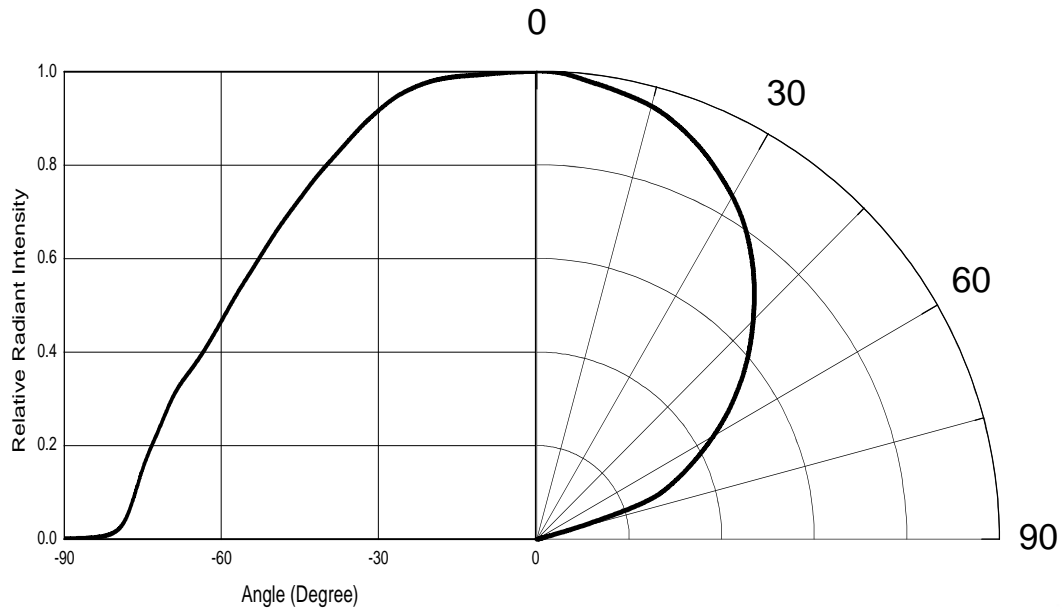

Fig.4 Forward Current vs. Forward Voltage



Typical Electro-Optical Characteristics Curves

Fig.5 Relative Radiant Intensity vs. Angular Displacement



JEDEC Moisture Sensitivity

Level	Floor Life		Soak Requirements Standard	
	Time (hours)	Conditions	Time (hours)	Conditions
1	unlimited	30 / 85% RH	168 (+5/-0)	85 / 85 RH

Reflow Soldering Characteristics

For Reflow Process

- C06 series are suitable for SMT processes.
- Curing of glue in oven must be according to standard operation flow processes.

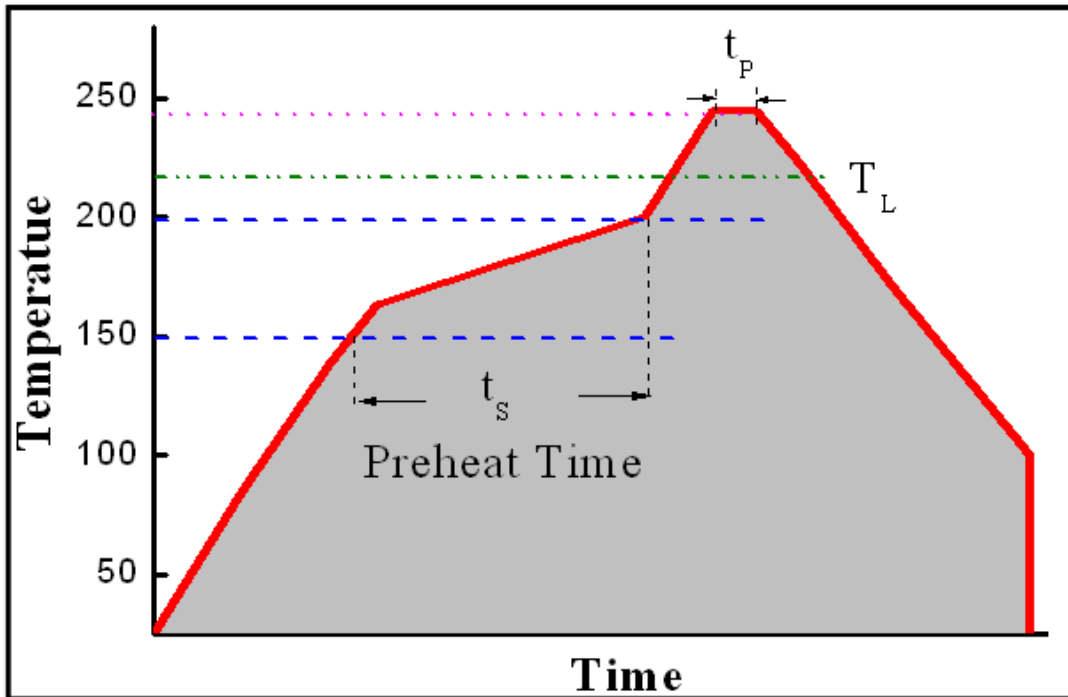

Profile Feature	Lead Free Assembly
Ramp-Up Rate	2-3 °C/S
Preheat Temperature	150-200 °C
Preheat Time (t_s)	60-120 S
Liquid Temperature (T_L)	217 °C
Time maintained above T_L	60-90 S
Peak Temperature (T_P)	240±5 °C
Peak Time (t_p)	Max 20 S
Ramp-Down Rate	3-5 °C/S

- Reflow soldering should not be done more than twice.
- In soldering process, stress on the LEDs during heating should be avoided.
- After soldering, do not bend the circuit board.

Package Dimensions

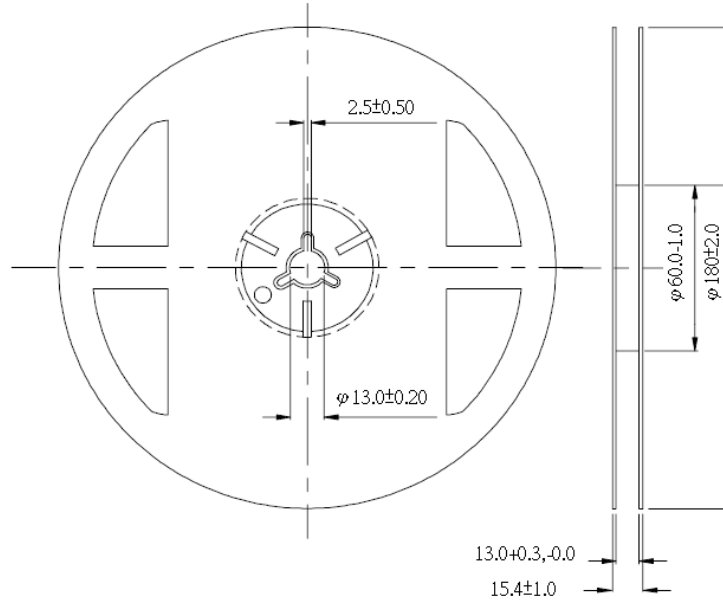

- Note:**
1. Dimensions are in millimeters
 2. The tolerances unless mentioned is ± 0.1 mm

Carrier Tape Dimensions:
Loaded quantity 400 PCS per reel.

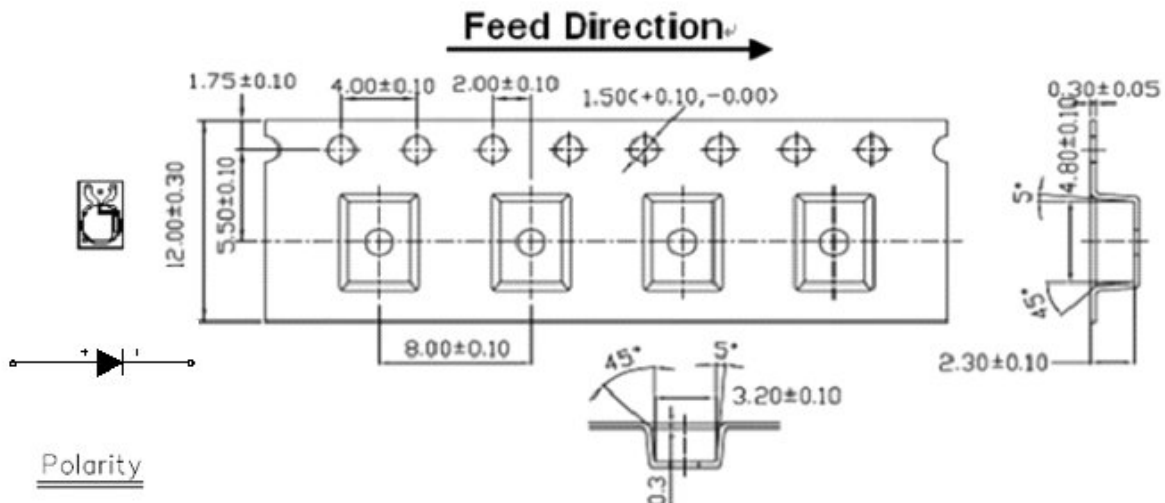

- Note:**
1. Dimensions are in millimeters
 2. The tolerances unless mentioned is ± 0.1 mm

Moisture Resistant Packaging

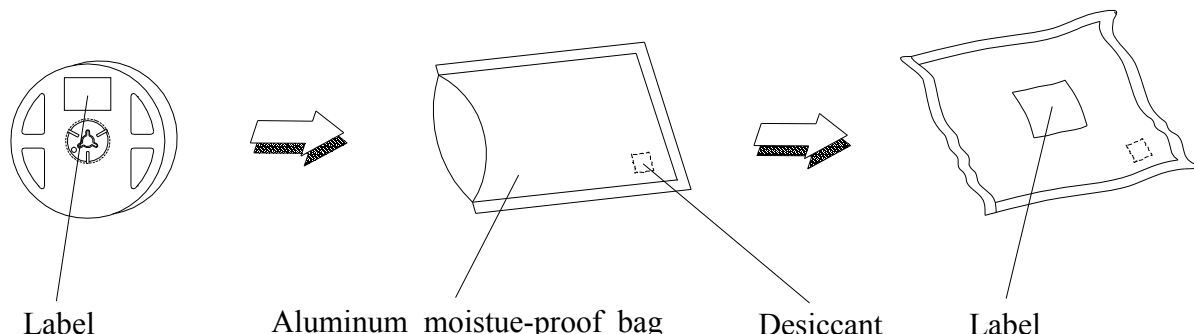

Label Form Specification



CPN: Customer's Production Number
P/N : Production Number
QTY: Packing Quantity
CAT: Ranks
HUE: Peak Wavelength
REF: Reference
LOT No: Lot Number
MADE IN TAIWAN: Production Place

Notes

1. Above specification may be changed without notice. EVERLIGHT will reserve authority on material change for above specification.
2. When using this product, please observe the absolute maximum ratings and the instructions for using outlined in these specification sheets. EVERLIGHT assumes no responsibility for any damage resulting from use of the product which does not comply with the absolute maximum ratings and the instructions included in these specification sheets.
3. These specification sheets include materials protected under copyright of EVERLIGHT corporation. Please don't reproduce or cause anyone to reproduce them without EVERLIGHT's consent.

EVERLIGHT ELECTRONICS CO., LTD.
Office: No 25, Lane 76, Sec 3, Chung Yang Rd,
Tucheng, Taipei 236, Taiwan, R.O.C

Tel: 886-2-2267-2000, 2267-9936
Fax: 886-2267-6244, 2267-6189, 2267-6306
<http://www.everlight.com>