

## Turbo 2 ultrafast high voltage rectifier

**Table 1. Main product characteristics**

$I_{F(AV)}$	12 A
$V_{RRM}$	600 V
$I_{RM}$ (typ.)	6 A
$T_j$ (max)	175 °C
$V_F$ (typ)	1.5 V
$t_{rr}$ (typ)	14 ns

### Features and benefits

- Ultrafast recovery
- Low reverse recovery current
- Reduces losses in diode and switching transistor
- Low thermal resistance
- Higher frequency operation
- Insulated voltage: 1500  $V_{RMS}$

### Description

ST's STTH12S06 is a state of the art Ultrafast recovery diode. By the use of 600 V Pt doping Planar technology, this diode will outperform the power factor correction circuits operating in hardswitching conditions. The extremely low reverse recovery current of the STTH12S06, reduces significantly the switching power losses of the MOSFET, and thus increases the

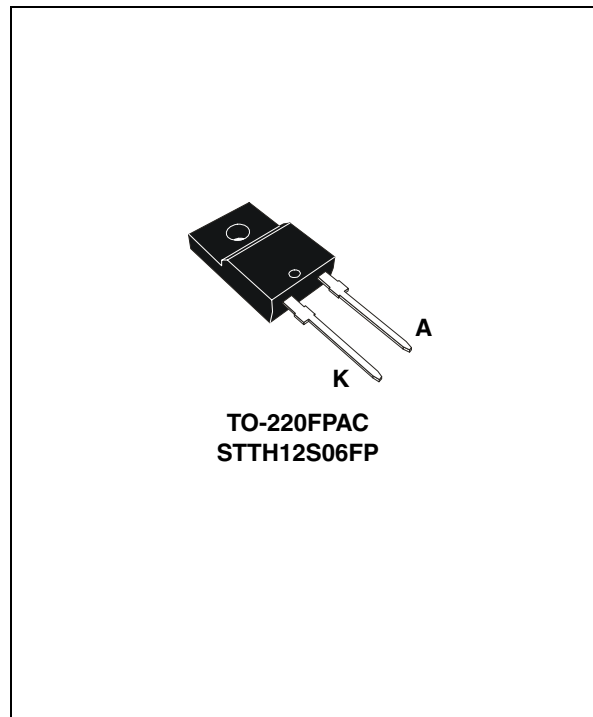

efficiency of the application. This allows designers to reduce the size of their heatsinks.

This device is also intended for applications in power supplies and power conversions systems, and other power switching applications.

**Table 2. Absolute ratings (limiting values at 125 °C, unless otherwise stated)**

Symbol	Parameter		Value	Unit
$V_{RRM}$	Repetitive peak reverse voltage		600	V
$I_{F(AV)}$	Average forward current		12	A
$I_{FSM}$	Surge non repetitive forward current	$t_p = 10$ ms sinusoidal	100	A
$T_{stg}$	Storage temperature range		- 65 + 175	°C
$T_j$	Maximum operating junction temperature		175	°C

# 1 Characteristics

**Table 3. Thermal resistances**

Symbol	Parameter	Value	Unit
Rth (j-c)	Junction to case	4.6	°C/W

**Table 4. Static electrical characteristics**

Symbol	Parameter	Tests conditions	Min.	Typ.	Max.	Unit
I <sub>R</sub>	Reverse leakage current	V <sub>R</sub> = 600 V	T <sub>j</sub> = 25 °C		30	μA
			T <sub>j</sub> = 125 °C		35	
V <sub>F</sub>	Forward voltage drop	I <sub>F</sub> = 12 A	T <sub>j</sub> = 25 °C		3.4	V
			T <sub>j</sub> = 150 °C		1.5	

**Table 5. Dynamic electrical characteristics**

Symbol	Tests conditions	Min.	Typ.	Max.	Unit
t <sub>rr</sub>	I <sub>F</sub> = 1 A dI <sub>F</sub> /dt = - 200 A/μs V <sub>R</sub> = 30 V		14	21	ns
I <sub>RM</sub>	V <sub>R</sub> = 400 V I <sub>F</sub> = 12A dI <sub>F</sub> /dt = - 200 A/μs	T <sub>j</sub> = 125 °C	6.0	8.0	A
S factor	V <sub>R</sub> = 200 V I <sub>F</sub> = 12A		0.3		
Q <sub>rr</sub>	dI <sub>F</sub> /dt = - 200 A/μs		160		nC

**Figure 1. Conduction losses versus average current**

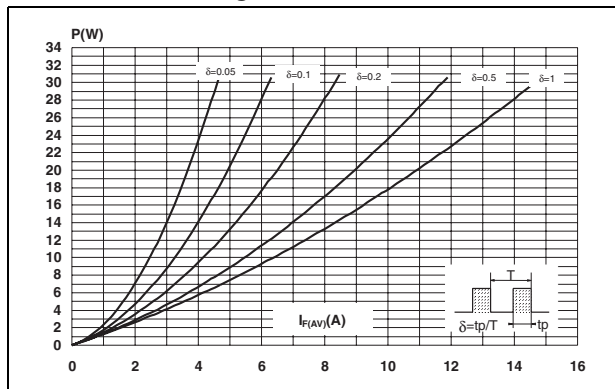

**Figure 2. Forward voltage drop versus forward current**

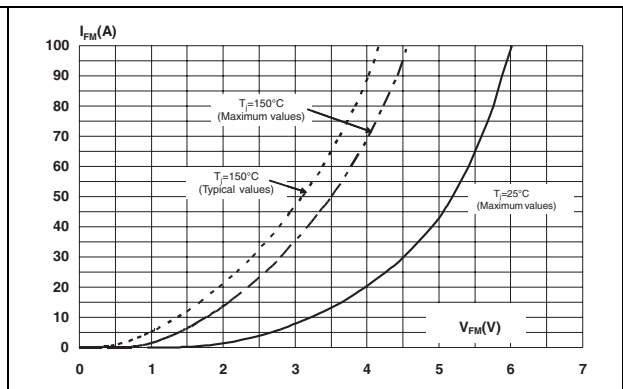

**Figure 3. Relative variation of thermal impedance, junction to case, versus pulse duration**

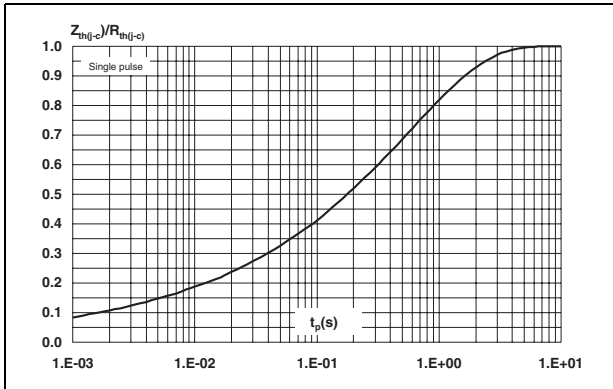

**Figure 4. Peak reverse recovery current versus  $di_F/dt$  (typical values)**

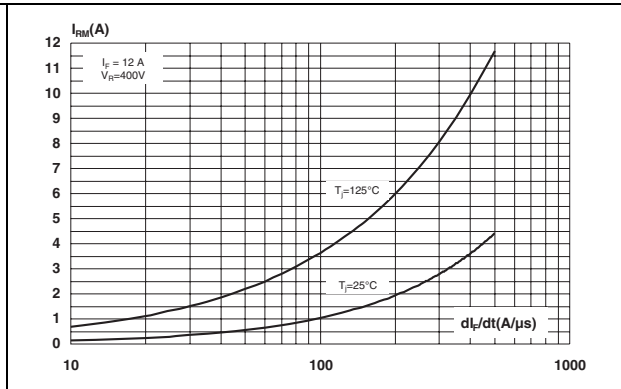

**Figure 5. Reverse recovery time versus  $di_F/dt$  (typical values)**

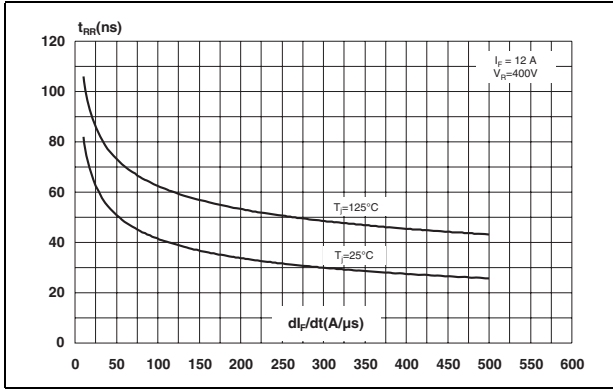

**Figure 6. Reverse recovery charges versus  $di_F/dt$  (typical values)**

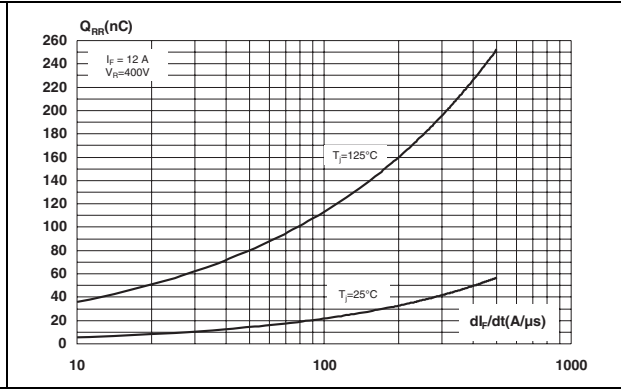

**Figure 7. Junction capacitance versus reverse voltage applied (typical values)**

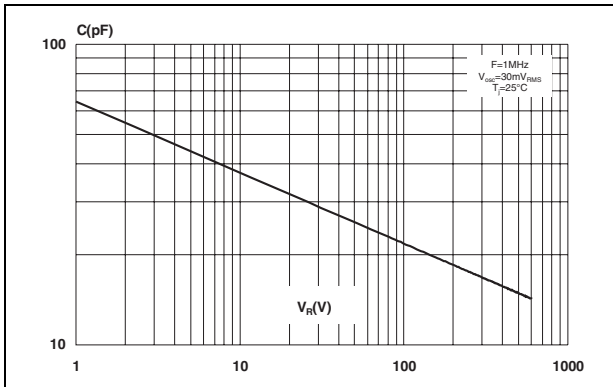

## 2 Package information

- Epoxy meets UL94, V0
- Cooling method: by conduction (C)
- Recommended torque value: 0.55 Nm
- Maximum torque value: 0.7 Nm

In order to meet environmental requirements, ST offers these devices in ECOPACK® packages. These packages have a lead-free second level interconnect. The category of second level interconnect is marked on the package and on the inner box label, in compliance with JEDEC Standard JESD97. The maximum ratings related to soldering conditions are also marked on the inner box label. ECOPACK is an ST trademark. ECOPACK specifications are available at: [www.st.com](http://www.st.com).

**Table 6. TO-220FPAC dimensions**

Ref.	Dimensions			
	Millimeters		Inches	
	Min.	Max.	Min.	Max.
A	4.4	4.6	0.173	0.181
B	2.5	2.7	0.098	0.106
D	2.5	2.75	0.098	0.108
E	0.45	0.70	0.018	0.027
F	0.75	1	0.030	0.039
F1	1.15	1.70	0.045	0.067
G	4.95	5.20	0.195	0.205
G1	2.4	2.7	0.094	0.106
H	10	10.4	0.393	0.409
L2	16 Typ.		0.63 Typ.	
L3	28.6	30.6	1.126	1.205
L4	9.8	10.6	0.386	0.417
L5	2.9	3.6	0.114	0.142
L6	15.9	16.4	0.626	0.646
L7	9.00	9.30	0.354	0.366
Dia.	3.00	3.20	0.118	0.126

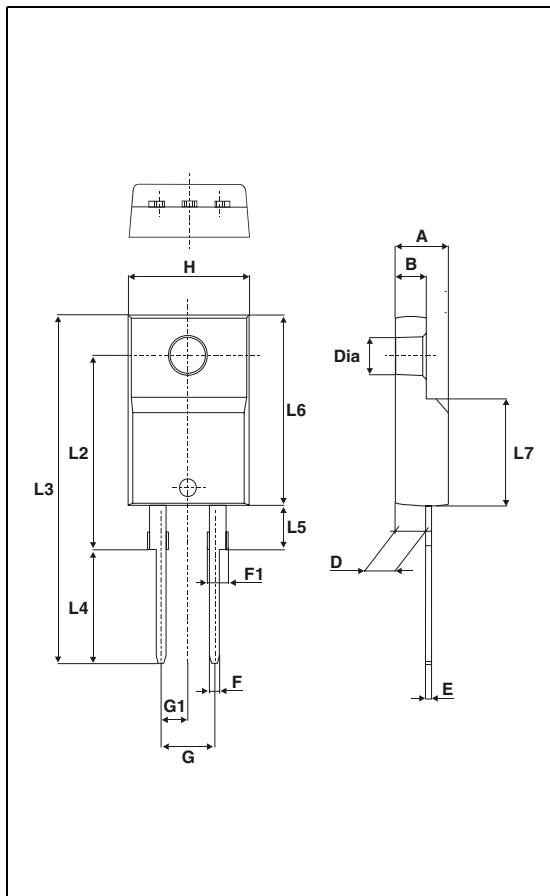

### 3 Ordering information

Table 7. Ordering information

Part number	Marking	Package	Weight	Base qty	Delivery mode
STTH12S06FP	STTH12S06FP	TO-220FPAC	1.64	50	Tube

### 4 Revision history

Table 8. Revision history

Date	Revision	Changes
02-Oct-2007	1	Initial release.

**Please Read Carefully:**

Information in this document is provided solely in connection with ST products. STMicroelectronics NV and its subsidiaries ("ST") reserve the right to make changes, corrections, modifications or improvements, to this document, and the products and services described herein at any time, without notice.

All ST products are sold pursuant to ST's terms and conditions of sale.

Purchasers are solely responsible for the choice, selection and use of the ST products and services described herein, and ST assumes no liability whatsoever relating to the choice, selection or use of the ST products and services described herein.

No license, express or implied, by estoppel or otherwise, to any intellectual property rights is granted under this document. If any part of this document refers to any third party products or services it shall not be deemed a license grant by ST for the use of such third party products or services, or any intellectual property contained therein or considered as a warranty covering the use in any manner whatsoever of such third party products or services or any intellectual property contained therein.

**UNLESS OTHERWISE SET FORTH IN ST'S TERMS AND CONDITIONS OF SALE ST DISCLAIMS ANY EXPRESS OR IMPLIED WARRANTY WITH RESPECT TO THE USE AND/OR SALE OF ST PRODUCTS INCLUDING WITHOUT LIMITATION IMPLIED WARRANTIES OF MERCHANTABILITY, FITNESS FOR A PARTICULAR PURPOSE (AND THEIR EQUIVALENTS UNDER THE LAWS OF ANY JURISDICTION), OR INFRINGEMENT OF ANY PATENT, COPYRIGHT OR OTHER INTELLECTUAL PROPERTY RIGHT.**

**UNLESS EXPRESSLY APPROVED IN WRITING BY AN AUTHORIZED ST REPRESENTATIVE, ST PRODUCTS ARE NOT RECOMMENDED, AUTHORIZED OR WARRANTED FOR USE IN MILITARY, AIR CRAFT, SPACE, LIFE SAVING, OR LIFE SUSTAINING APPLICATIONS, NOR IN PRODUCTS OR SYSTEMS WHERE FAILURE OR MALFUNCTION MAY RESULT IN PERSONAL INJURY, DEATH, OR SEVERE PROPERTY OR ENVIRONMENTAL DAMAGE. ST PRODUCTS WHICH ARE NOT SPECIFIED AS "AUTOMOTIVE GRADE" MAY ONLY BE USED IN AUTOMOTIVE APPLICATIONS AT USER'S OWN RISK.**

Resale of ST products with provisions different from the statements and/or technical features set forth in this document shall immediately void any warranty granted by ST for the ST product or service described herein and shall not create or extend in any manner whatsoever, any liability of ST.

ST and the ST logo are trademarks or registered trademarks of ST in various countries.

Information in this document supersedes and replaces all information previously supplied.

The ST logo is a registered trademark of STMicroelectronics. All other names are the property of their respective owners.

© 2007 STMicroelectronics - All rights reserved

STMicroelectronics group of companies

Australia - Belgium - Brazil - Canada - China - Czech Republic - Finland - France - Germany - Hong Kong - India - Israel - Italy - Japan - Malaysia - Malta - Morocco - Singapore - Spain - Sweden - Switzerland - United Kingdom - United States of America

[www.st.com](http://www.st.com)