

# **Instruction Manual for Evaluation Board of The TB6641FG**

July 28, 2016

Rev.1.0

## 【Outline】

The TB6641FG is a brushed DC motor driver corresponding to the constant current PWM control system and the direct PWM control system.

BiCD process is adopted. Ratings of 50V and 4.5A (@ Power supply voltage (VM) ≤ 36V) are realized. When the power supply voltage (VM) is more than 36V, please use the IC by configuring the current range of 4.0A or less.

This evaluation board mounts necessary components to evaluate the IC.

Brushed DC motor can be controlled by the direct PWM drive.

In case of controlling the brushed DC motor by the constant current PWM drive, please remove the short resistor (0Ω), which is mounted to R2. Then, replace the current detection resistor that is appropriate for the constant current PWM control.

Please sense controllability of a brushed DC motor by applying the TB6641FG.

## 【Note】

In using, please be careful about the thermal condition sufficiently.

For each control signal, please refer to the IC specifications by accessing to the following URL:

<http://toshiba.semicon-storage.com/info/lookup.jsp?pid=TB6641FG&region=jp&lang=ja>

Further, the application of this evaluation board is limited to the purpose of evaluating and learning the motor control. Please do not ship them to a market.

# Connection to Evaluation Board 1 【Direct PWM Control】

## Correspondence table of silk name and signal name

Please pay attention that the silk name and the signal name of the board are different because the TB6641FG and the series ICs use the common board.

Silk name	Signal name
VISD	VREG

\*Supply the power in using the switch on the board.

Power supply for board: VDD (3.0V to 5.5V)

Power supply for motor: VM (10V to 47V)

Motor control signal input

Motor control signal input

Brushed DC motor

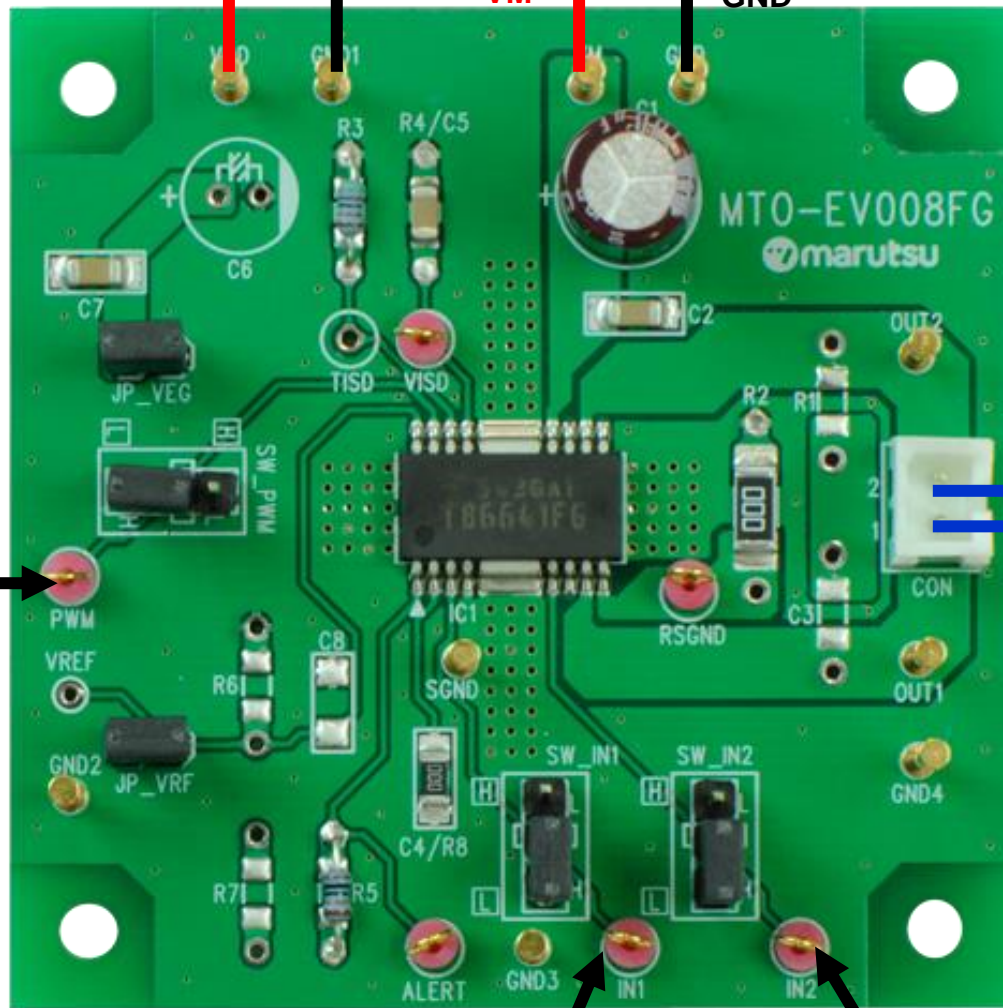

# Connection to Evaluation Board 2 【Constant Current PWM Control】

\*Supply the power in using the switch on the board.

## Correspondence table of silk name and signal name

Please pay attention that the silk name and the signal name of the board are different because the TB6641FG and the series ICs use the common board.

Silk name	Signal name
VISD	VREG

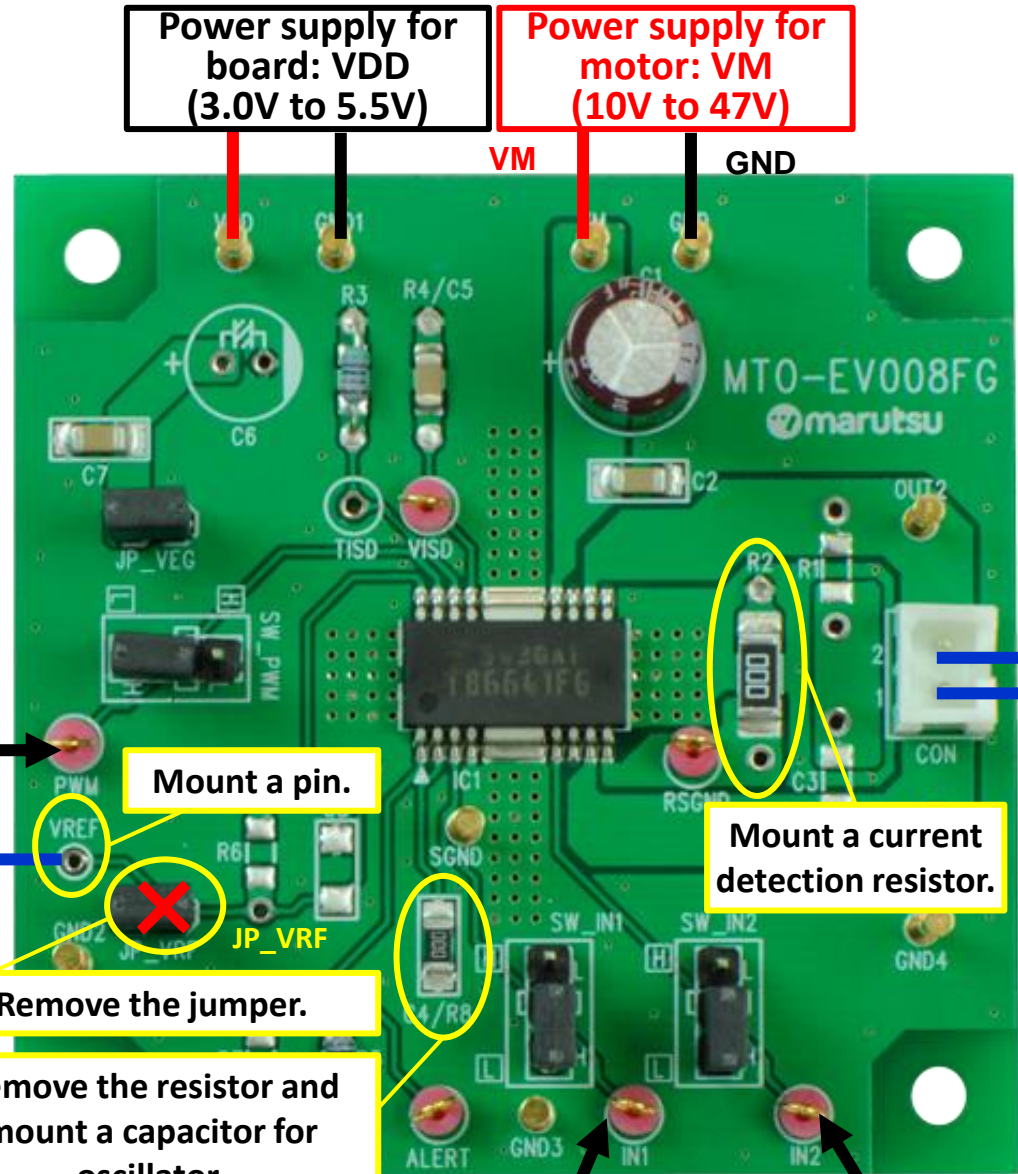

Power supply for board: VDD (3.0V to 5.5V)

Power supply for motor: VM (10V to 47V)

Brushed DC motor

Motor control signal input

Reference voltage for motor current set Vref (0V to 3.6V)

Mount a pin.

Mount a current detection resistor.

Remove the jumper.

Remove the resistor and mount a capacitor for oscillator.

Motor control signal input



# Setting Evaluation Board 1

## Setting motor current

## Setting motor current

$$I_{out(max)} = V_{REF(gain)} \times \frac{V_{ref}(V)}{R_{RS}(\Omega)}$$

$V_{REF(gain)}$ : Decay ratio of  $V_{REF} = 1/10.0$  (typ.).

Current detection resistor should be remounted on the board because the resistor of  $R_{RS}$  ( $0\Omega$ ) is mounted.

## Waveform of motor current

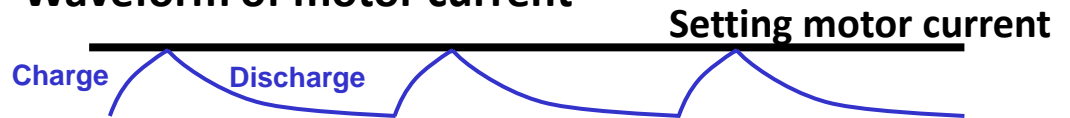

## Setting formula of OSC frequency

$$f_{OSC} = 0.42 / (C_{osc}[F] \times 10^3)$$

\* It is adjusted by the capacitor connected to C4/R8.

## Relation of the motor current waveform and the discharge term.

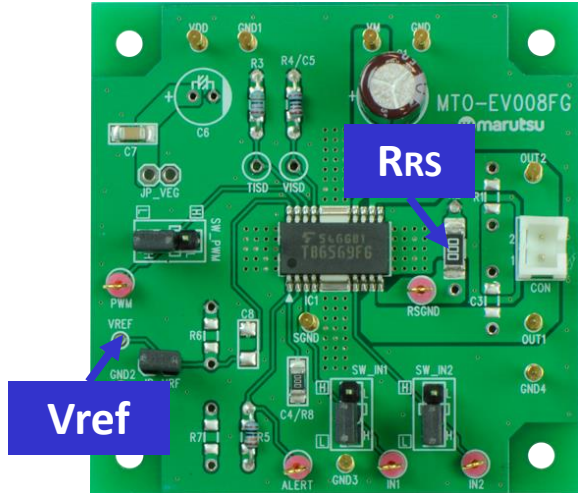
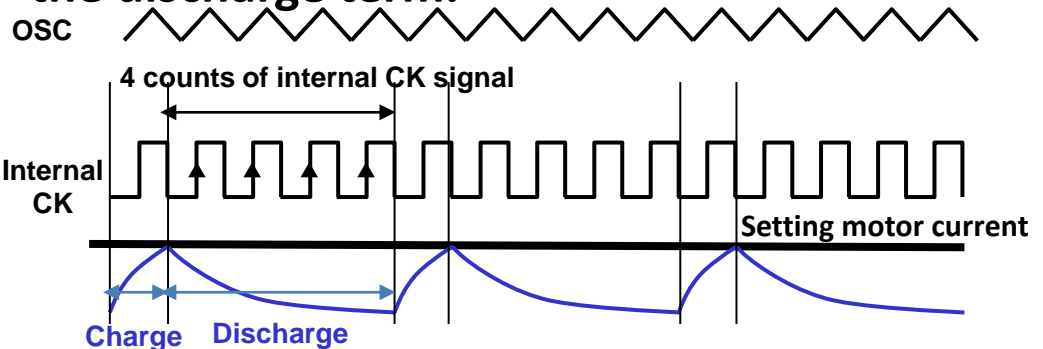

## Setting discharge term of constant current control

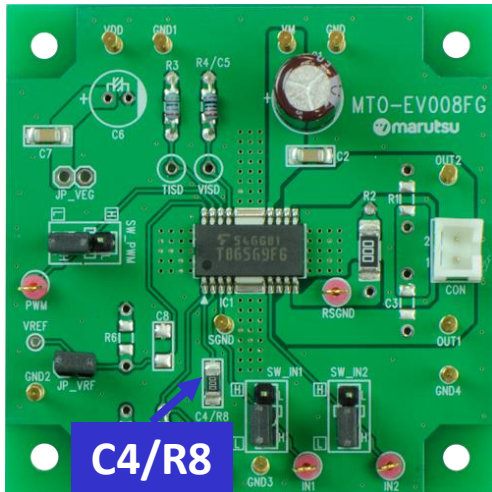



# Setting Evaluation Board 2

## Setting motor operation

Jumper indicated on the right is adopted on this evaluation board to supply the high-level voltage to the switch. This voltage is supplied from 5V-regulator of the internal IC. In this case, please connect JP\_VEG directly.

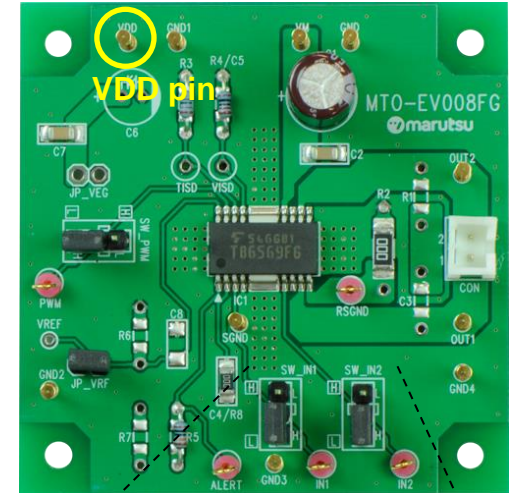

【Enhanced figure of jumper part】

Jumper indicated on the right is adopted on this evaluation board to set operation of the TB6641FG. To select the function by the jumper, connect JP\_VEG directly as in the above figure or supply the voltage of high level by VDD pin.

In the right figure, fixed level of the silk near the jumper is indicated inside the white frame. Please change the short position according to the configuration of the usage function.

In case of inputting the signal externally, please remove the short pin.

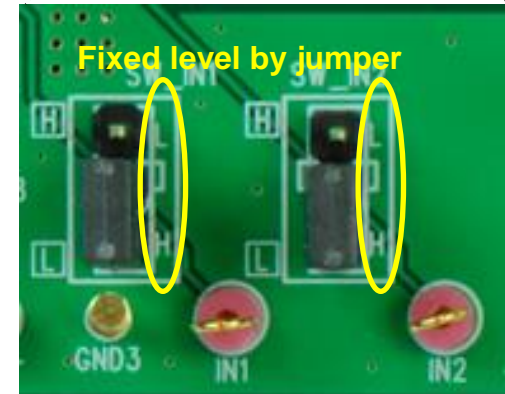

# Circuit of Evaluation Board

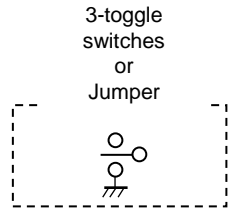
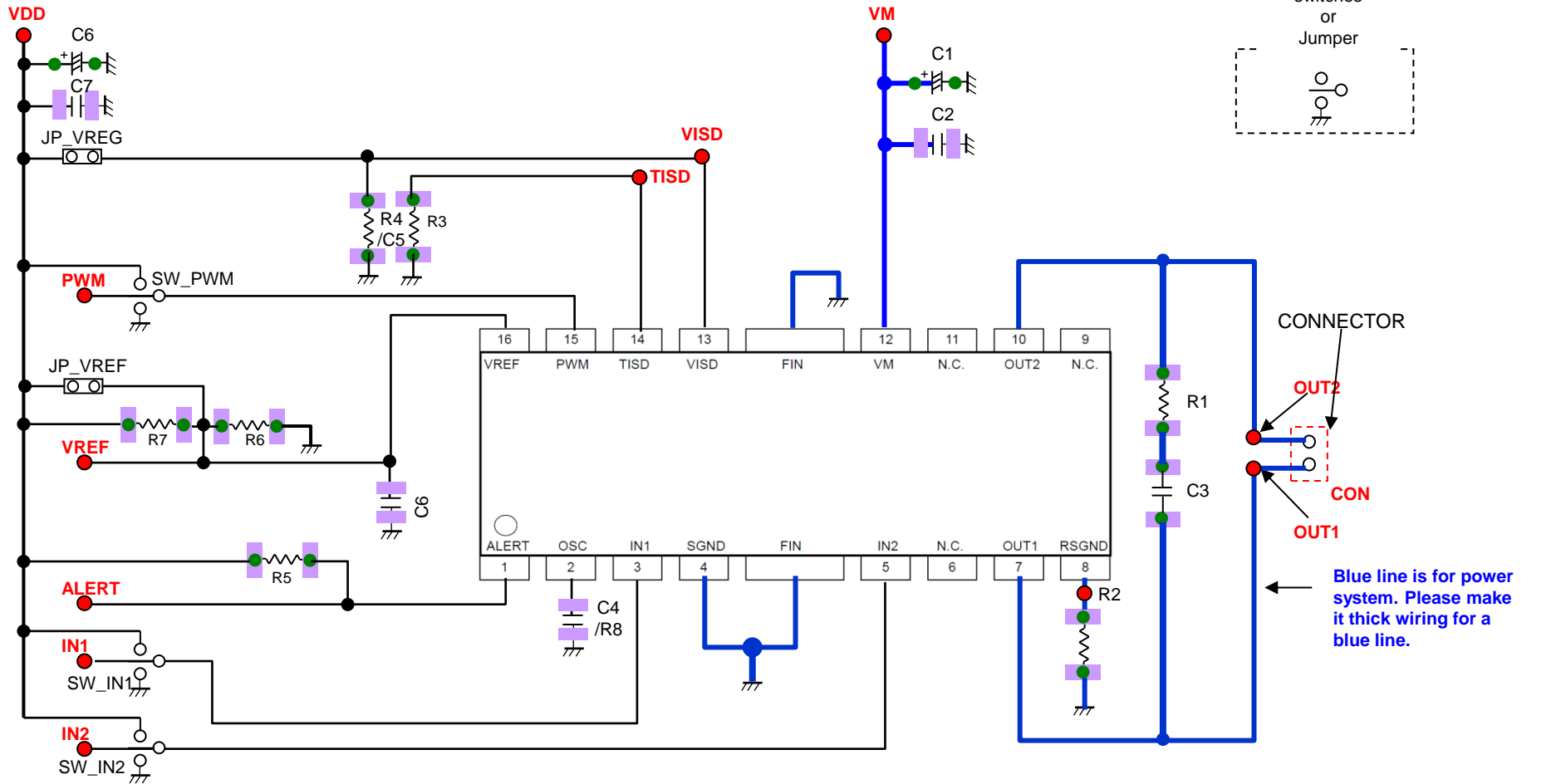

CONNECTOR

OUT2  
CON  
OUT1

Blue line is for power system. Please make it thick wiring for a blue line.

- : Socket pin
- : Check pin
- : Jumper
- : Solder land+ Through hole
- (Please provide the land for surface-mounting component which has a through hole.)
- : Solder land